

CT3451 Programmable Thermostat

OWNER'S GUIDE



Programmable Heat and/or Cool
Low Voltage (20 to 30 Vac) Thermostat and Wallplate

Congratulations on the purchase of your new thermostat! More than 100 years of Honeywell engineering produced this thermostat that can provide you with a more comfortable and convenient living environment.

Your new thermostat automatically controls the temperature in your home, keeping you comfortable while saving energy when programmed according to these instructions.

Direct questions about this thermostat to our Web site at www.honeywell.com/yourhome or call the customer information line at 1-800-468-1502.

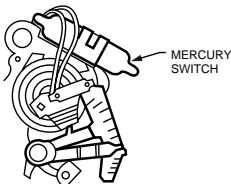

TYPICAL LOCATION OF A MERCURY SWITCH IN A THERMOSTAT

M10614



MERCURY NOTICE

If this control is replacing a control that contains mercury in a sealed tube, do not place your old control in the trash. Dispose of it properly.

Contact your local waste management authority for instructions regarding recycling and the proper disposal of an old control.

1 PREPARE FOR INSTALLATION

- ❑ Check Table 1 to make sure this thermostat is compatible with your system. If not, return it to the retailer.
- ❑ Acquire tools and items, as needed. See Fig. 1.

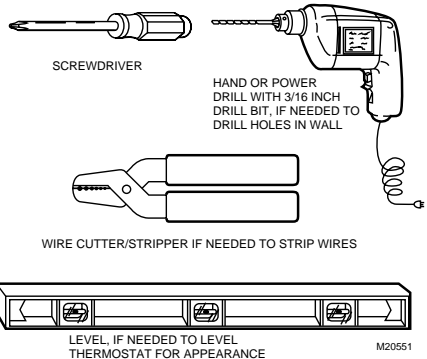

Fig. 1. Required installation tools/supplies.



2 REMOVE OLD THERMOSTAT

- Test to be sure your heating and air conditioning systems (where applicable) are working correctly. If not, contact your local heating/air conditioning dealer. To avoid compressor damage, do not operate the

cooling system when outdoor temperature is below 50°F (10°C).

Table 1. Compatibility Chart.

System Type	Compatible With CT3451
Gas—standing pilot	Yes
Gas—electronic ignition	Yes
Gas-fired boilers	Yes ^a
Gas—750 millivolt	Yes
Oil-fired boilers	Yes ^a
Oil-fired furnace	Yes
Electric furnace	Yes
Electric air conditioning	Yes
Single stage heat pumps (no backup or auxiliary heat)	Yes
Baseboard electric (120/240 line volt)	No
Multistage heat pumps/multistage equipment	No

Not compatible with any 120/240 volt circuit.

^aCompatible with 2-wire Honeywell zone valves. Isolating relay required for zone valves that have a 3-wire thermostat connection.

CAUTION

Equipment Damage Hazard.
Handling wires during installation can damage equipment.
 Disconnect power at furnace or main breaker/ fuse box before beginning installation.

- Carefully unpack your new thermostat and wallplate and save package of screws, instructions and receipt.
- Remove the cover from the old thermostat. If it does not snap off when pulled firmly from the bottom, check for screw that locks on the cover.
- Loosen screws holding thermostat to subbase, wallplate or wall and lift away.
- Disconnect wires from old thermostat or subbase. As you disconnect each wire, use the wiring labels (enclosed) to label each wire with the old terminal designation. If there are only two wires, they do not require labeling. Wrap wires around a pencil to keep them from falling back into the wall as shown in Fig. 2.

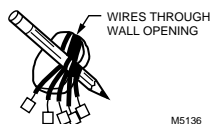

M5136

Fig. 2. Wrapping wires around pencil.

Replacing Clock With C or C1 Clock Terminals

If you are replacing a Honeywell Chronotherm® Thermostat, you may find one or two wires that go to the C or C1 clock terminals on the Chronotherm® Thermostat wiring wallplate. Do not allow them to touch, or you can damage your transformer. Disconnect the wires and wrap them separately using electrical tape; do not wrap them together. Do not place the wires where they can interfere with the new thermostat operation. Record the colors and terminal designation labels of the remaining wires.

Six or More Thermostat Wires

If there are six or more wires connected to the thermostat (excluding clock wires attached to terminals), you probably have a variation of a multistage heat pump or other multistage system. The thermostat is not compatible with these systems, so return the product to your retailer. If you want information about which programmable thermostats work with your system, visit our Web site at www.honeywell.com/yourhome or call the customer information line at 1-800-468-1502.

Three Thermostat Wires

If you have three wires for heating only and can operate the fan using the Fan On switch, this thermostat works with your system. However, some hot water (zoned) heating systems have three thermostat wires. The thermostat works only if a contractor installs an isolating relay on these systems. For details, contact a local heating/cooling contractor.

3 MOUNT WALLPLATE

IMPORTANT

Level for appearance only. The thermostat functions normally even when not mounted level.

- Position the wallplate on the wall. Level the wallplate for appearance, if desired. Use a pencil to mark the two mounting holes that best fit the application. See Fig. 3.

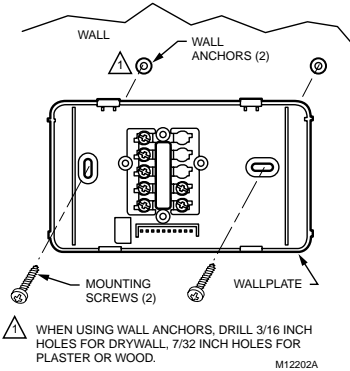

Fig. 3. Mounting wallplate to wall.

- Remove the wallplate from the wall and drill two 3/16-in. holes in the wall (if drywall). For firmer wall material such as plaster or wood, drill 7/32-in. holes. Gently tap provided anchors into the drilled holes until flush with the wall.
- Reposition the wallplate, pulling wires through the wiring opening. Loosely insert the mounting screws into the holes.
- Level for appearance only; the thermostat functions correctly even when not level. Tighten the mounting screws.

4 WIRE WALLPLATE TERMINALS

All wiring must comply with local electrical codes and ordinances. If unsure about household wiring procedures, call your local heating and air conditioning contractor.

Refer to the labels you placed on wires when you removed your old thermostat.

- Match the letter of your old thermostat wire with the terminal of the corresponding letter on your new thermostat. Refer to Fig. 4.

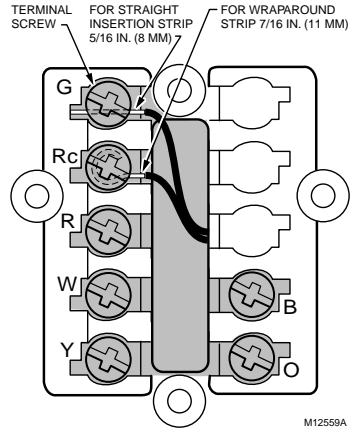

Fig. 4. Connecting wiring.

NOTE: To ensure correct mounting of thermostat, restrict all wiring to the shaded area in the center of the terminals.

- Loosen the terminal screws and slip each wire beneath its matching terminal. The shape of the terminals permit insertion of straight or wraparound connections. See Fig. 5. Tighten the terminals.

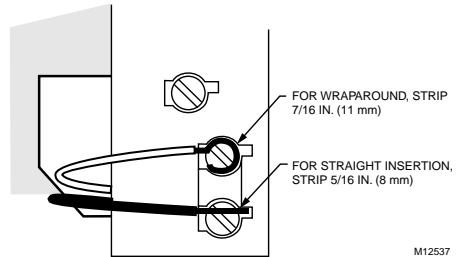

Fig. 5. CT3451 methods for wiring connection.

- Plug the hole in the wall with insulation to help prevent drafts from adversely affecting thermostat operation.

The CT3451 Thermostat is powered with 3AA alkaline batteries and is adaptable to most 18 to 30 Vac heating-cooling systems. Refer to Fig. 6 through 10 for typical system wiring diagrams.

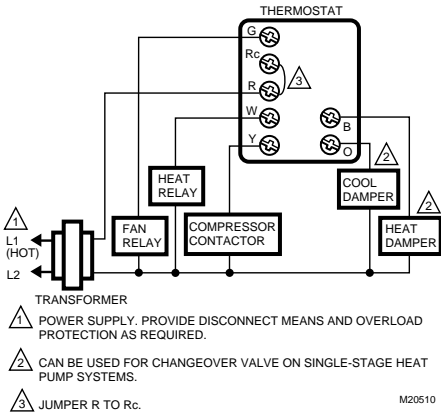

Fig. 6. Typical heat-cool system hookup with single transformer.

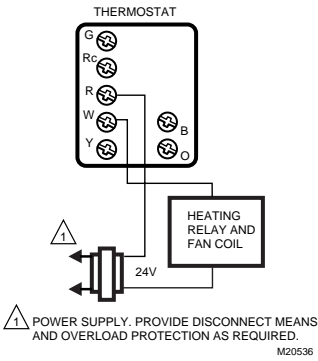

Fig. 7. Typical heat system hookup with 2-wire, heat-only system.

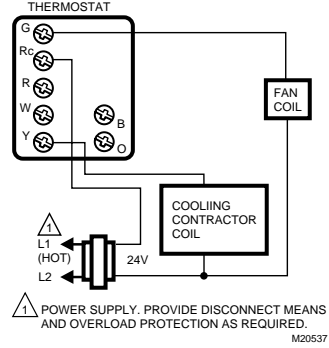

Fig. 8. Typical cool system hookup with 3-wire, cool-only system.

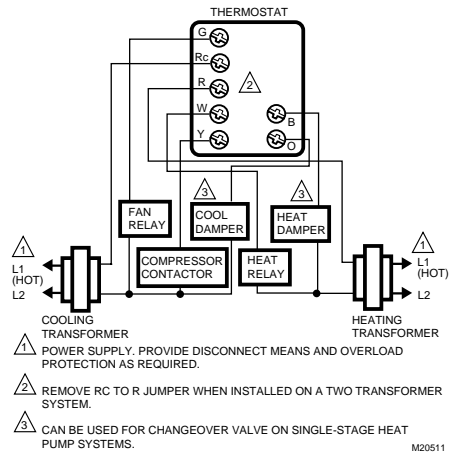

Fig. 9. Typical heat-cool system hookup with two transformers.

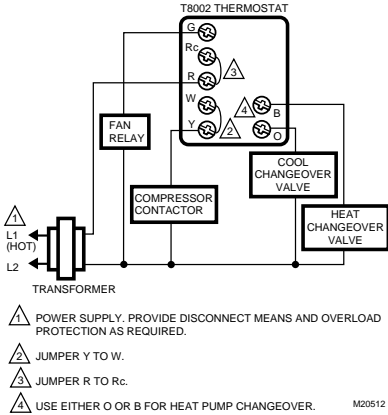

Fig. 10. Typical single-stage heat pump system hook-up.

5 ADJUST FAN OPERATION SWITCH

The thermostat fan operation switch, labeled fuel switch in Fig. 11, is set at the factory in the F (gas/oil fuel) position. This is the correct setting for most systems. If you have an electric heat system, set the switch to the E (electric) position. The E setting allows the fan to turn on immediately with the heating equipment in a system where the G terminal is connected. See Fig. 11.

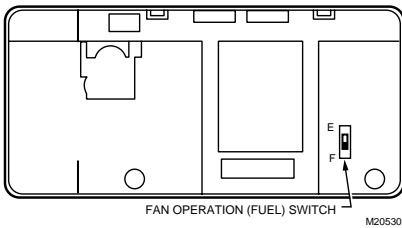
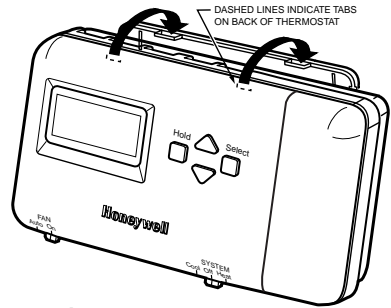

Fig. 11. Fan operation (fuel) switch.

6 MOUNT THERMOSTAT TO WALLPLATE

- Slide System switch to the Off position.
- Engage the tabs at the top of the thermostat and wallplate.

- Swing down the thermostat and press the lower edge of the thermostat onto the wallplate to latch. See Fig. 12.



A ENGAGE TABS AT TOP OF THERMOSTAT WITH SLOTS ON WALLPLATE.

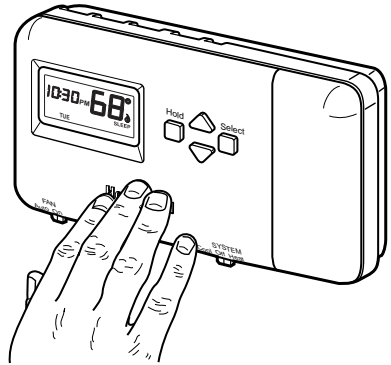

B PRESS LOWER EDGE OF CASE TO LATCH.

Fig. 12. Mounting thermostat to wallplate.

7 INSTALLING AND REPLACING BATTERIES

The thermostat requires three AA alkaline batteries to operate:

- Remove the battery door, located on the right side of the thermostat, by pulling outward from the bottom. See Fig. 13.
- Insert three AA alkaline batteries as shown in Fig. 13.

NOTE: The thermostat shows a “bAtLo” message on the digital display to alert the homeowner one to two months before the batteries run out completely.

IMPORTANT

Homeowner should replace the batteries once a year to prevent leakage and/or the heating/cooling system from shutting down due to lack of battery power in the thermostat.

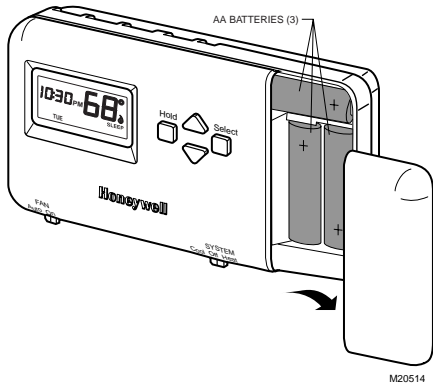

Fig. 13. Installing batteries.

- Restore power to the heating/cooling system.

8 CUSTOMIZE YOUR THERMOSTAT

Your Honeywell thermostat comes preset to the most commonly used settings:

- Temperature (°F).
- Gas or oil forced air furnace.
- Aggressive algorithm control.

You can change these settings using the instructions that follow. To exit at any time, press the ▲ key until End displays.

Setting °F/°C Indication, Heat Cycle Rate, Heating/Cooling Temperature Control

The following instructions provide information to change the heating cycle rate to match the heating equipment and to choose either the Fahrenheit (°F) or Celsius (°C) display.

NOTE: All four steps must be completed to save changes to the °F/°C indication and the heat cycle rate.

- Enter Installer Setup.
 - Use ▼ or ▲ keys to set the temperature setpoint to 52°F (11°C).



M12582A

- Press ▼ and ▲ keys simultaneously for more than two seconds to enter Installer Setup.

- Release the keys to display the three-digit software revision code. (Information displayed varies by model).

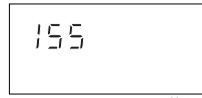

M12583

- Press the ▲ key. FC (factory configuration) displays. (A typical example is shown, but information displayed varies by model. This information is for factory use only.)



M12584A

- Setting °C or °F.
 - Press the ▲ key again to display the current setting.
 - Press the ▼ key to change the °C or °F indication.
- Setting Heat Cycle Rate (see Table 2 for the cycle rate options and equipment).
 - Press the ▲ key to display the current heat cycle rate setting of 1, 3, 4, 5, 9, or 12 cph.



M12589A

- If the desired cycle rate is displayed, press the ▲ key to display heating and cooling algorithm default.



M12588A

- To change the heat cycle rate, press the ▼ key until your choice of 1, 3, 4, 5, 6, 9, or 12 is displayed.
- Press the ▲ key to display the heating and cooling temperature control algorithm configuration default.



M14691

- Press the ▼ key to change the heating and cooling control algorithm to C1 or C3.
 - C1 = Standard control algorithm.
 - C3 = Aggressive control algorithm (Default. Can cause overshooting.)

- Press the ▲ key. Current configuration (CC) is displayed. A typical example is shown, but CC varies by model. (This information is for factory use only.)

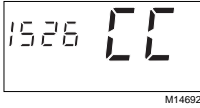

NOTE: The heating and cooling program times are the same. Changing your cooling Wake time also changes your heating Wake time.

Leave is the time period you can set for an energy saving temperature while you are away from home during the day.

Return is the time period when you want the house at a comfortable temperature when you come home during the day.

Sleep is the time period when you can set an energy-saving temperature while you are sleeping.

IMPORTANT

Always press the keys with your fingertip or similar blunt tool. Sharp instruments like pens and pencil points can damage the keyboard.

Setting Current Time and Day

1. To set current time, press Select twice. Press ▼ or ▲ key to set current time.

NOTE: While setting the current time, the word SET is displayed.

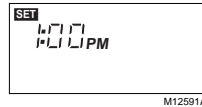

2. To set day of week, press Select again. Press ▼ or ▲ key to set current day.

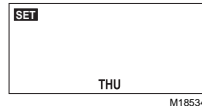

To use the preprogrammed time and temperature settings (see Table 3), press Hold to exit the programming mode.

Setting Weekday Program

Slide the System switch to the position, Heat or Cool, that you want to program. A flame 🔥 (heating) or a snowflake ❄️ (cooling) appears in the right side of the display, when setting the program temperature.

1. Wake
 - a. Press Select. Press ▼ or ▲ key to set Wake time.

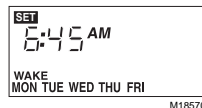

- b. Press Select. Press ▼ or ▲ key to set Wake temperature.

Table 2. Heating Cycle Rate.

System	Cycle Per Hr
Steam, gravity	1
Hydronic heat, condensing gas furnaces ^a	3
Gas or oil forced air (default)	6
Electric heat	9
Special applications	4, 5, 12

^aHigh efficiency furnace (90+).

^bRefer to the equipment manufacturer's instructions.

9 PROGRAM YOUR THERMOSTAT

The thermostat is preprogrammed for your convenience with the following time and temperature settings; see Table 3. See energy saving charts at the end of this document for energy-saving information.

Table 3. Preprogrammed Time and Temperature Settings.

Period	Time	Heat Setpoint	Cool Setpoint
Wake	6:00 AM	70°F (21°C)	78°F (26°C)
Leave	8:00 AM	62°F (17°C)	85°F (29°C)
Return	6:00 PM	70°F (21°C)	78°F (26°C)
Sleep	10:00 PM	62°F (17°C)	82°F (28°C)

Wake is the time period when you want the house at a comfortable temperature when you get up in the morning.



2. Leave.
 - a. Press Select. Press ▼ or ▲ key to set Leave time.



- b. Press Select. Press ▼ or ▲ key to set Leave temperature.

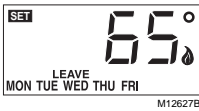

3. Return
 - a. Press Select. Press ▼ or ▲ key to set Return time.



- b. Press Select. Press ▼ or ▲ key to set Return temperature.

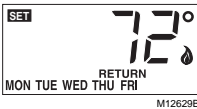

4. Sleep
 - a. Press Select. Press ▼ or ▲ key to set Sleep time.

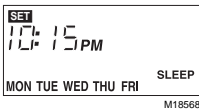

- b. Press Select. Press ▼ or ▲ key to set Sleep temperature.



Setting Saturday and Sunday Programs

To set the Saturday program:

1. Wake
 - a. Press Select. Press ▼ or ▲ key to set Wake time.

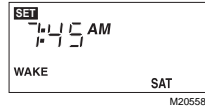

- b. Press Select. Press ▼ or ▲ key to set Wake temperature.



2. Leave
 - a. Press Select. Press ▼ or ▲ key to set Leave time.

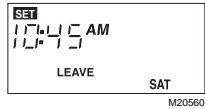

- b. Press Select. Press ▼ or ▲ key to set Leave temperature.

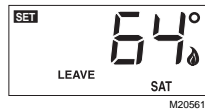

3. Return
 - a. Press Select. Press ▼ or ▲ key to set Return time.

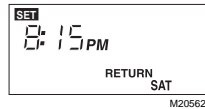

- b. Press Select. Press ▼ or ▲ key to set Return temperature.



4. Sleep
a. Press Select. Press ▼ or ▲ key to set Sleep time.

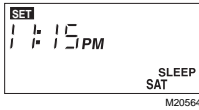

- b. Press Select. Press ▼ or ▲ key to set Sleep temperature.

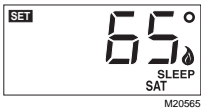

5. Repeat steps 1-4 in Setting Saturday and Sunday Program section to set the Sunday program.
6. Press Select. End is displayed. Programming is complete. The thermostat reverts to displaying the current day time and temperature in five seconds.

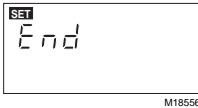

7. Repeat programming steps to set heat or cool program, as desired.

10 OPERATE YOUR THERMOSTAT

Displaying Temperature Setting

- Press ▼ or ▲ key once to display present temperature setting. After approximately five seconds, the thermostat displays the current time and room temperature.

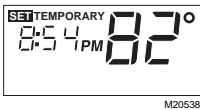

Setting Temporary Temperature Hold

- Press ▼ or ▲ key to set a temporary temperature setting.



NOTE: The temporary temperature setting remains in effect until the next program period. To cancel, press Hold twice.

Setting Indefinite Temperature Hold

The Hold key allows you to indefinitely hold a temperature. When Hold is active, the letters Hld are displayed continuously. Hold can be canceled by pressing the Hold key again.

- Press Hold.
 Press ▼ or ▲ key to set indefinite temperature setting.



11 SET FAN AND SYSTEM SWITCHES

Manually control Fan and System settings using the switches located at the bottom of the thermostat case. See: Fig. 14 for switch locations.

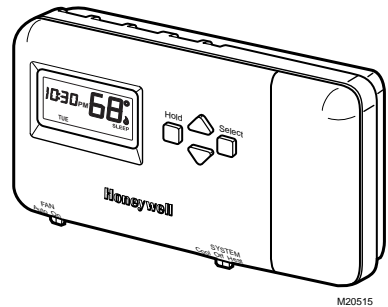

Fig. 14. Time/temperature display and System/Fan switches.

Fan Switch

- The Fan switch settings are:
On: The fan runs continuously. Use for improved air circulation.



Auto: Normal setting for most homes. In cooling, the fan starts and stops with the cooling equipment. In heating, the fan is controlled directly by the heating equipment and starts a few minutes after the heating equipment turns on (on most systems). When the thermostat fuel switch is set to the E position for electric heat, the fan starts and stops with the heating equipment.



- Slide the Fan switch on the thermostat to the desired fan setting.

System Switch

- The System switch settings control thermostat operation as follows:
 - Cool: The thermostat controls the cooling system.
 - Off: Both heating and cooling are off.
 - Heat: The thermostat controls the heating system.
- Slide the System switch on the thermostat to the desired system setting.

Heat and Cool Indicators

-  indicates a call for heat.
-  indicates a call for cool.

NOTE: In the programming mode, the  and the  indicate System setting.

Minimum Off-Timer

The thermostat minimum off-timer assures that the compressor does not come on again for at least five minutes after it turns off.

The minimum off-timer is triggered when the compressor turns off and when the System switch position is changed. If the compressor turns off when the setpoint is changed, the minimum off-timer is triggered.

A flashing snowflake  indicates the minimum off-timer is in effect.

12 CHECK OPERATION AFTER INSTALLATION/PROGRAMMING

Heating System

- Slide the System switch to Heat and the Fan switch to Auto.
- Press and hold the  key to raise the temperature several degrees above the room temperature to start the heating equipment. When using the thermostat

with the Fuel switch set to the E position for electric heat, the fan starts immediately.

- Press the  key to lower the temperature setting below the room temperature. The heating equipment should shut down.

Cooling System



CAUTION

Compressor Damage Hazard.
Operating at too low of an outdoor temperature can cause compressor damage.
 Do not operate cooling if outdoor temperature is below 50°F (10°C).
 Allow compressor to remain off for five minutes before restarting.
 Refer to manufacturer's recommendations.

1. Slide the System switch to Cool and the Fan switch to Auto.
2. Press the  key to lower the temperature setting several degrees below the room temperature; the cooling equipment should start. The fan starts and stops with the cooling equipment.

NOTE: If the cooling system does not start immediately, remember that the thermostat has a built-in minimum off-time of five minutes to protect the compressor.

3. Press the  key to raise the temperature setting above the room temperature. Cooling system should shut down.

Fan





- Slide the System switch to Off and the Fan switch to On. The fan should run continuously.
- Slide the Fan switch to Auto. The fan should turn off.

Backlighting

- Press any key to light the display for approximately ten seconds.

TROUBLESHOOTING

Table 4. Frequently Asked Questions.

If ...	Then ...
Display does not come on.	Make sure the batteries are fresh and installed correctly.
Temperature display does not go lower than 40°F (4°C) or higher than 99°F (37°C) during programming.	Your thermostat has reached the temperature limit. Be sure the setting range is from 40°F to 99°F (4°C to 37°C).
Display shows flashing or steady "bAtLo."	The batteries are low; replace them as soon as possible.
Temperature change occurs at the wrong time.	Check the program times for the period in question. Be sure that AM and PM indications are correct. Make sure the current day and time are correct. Reprogram if necessary.
Heating does not come on.	<ul style="list-style-type: none"> • Check that the System switch is set to Heat. • Check the system fuse or circuit breaker and replace or reset, if necessary. • Check for correct wiring and good connections. • If display is blank or displays "bAtLo," install fresh batteries. • Allow time for the furnace to heat up and the fan to come on before checking for heat at the register. • If the temperature setting is higher than the current room temperature and the flame  is displaying, the thermostat is operating correctly. Contact a heating contractor for assistance.
Cooling does not come on.	<ul style="list-style-type: none"> • Check that the System switch is set to Cool. • Check the system fuse or circuit breaker and replace or reset, if necessary. • Check for correct wiring and good connections. • If display is blank or says "bAtLo," install fresh batteries. • The thermostat has a built-in time delay on cooling. Allow five to ten minutes after changing the setting before the air conditioner starts. • If the temperature setting is lower than the current room temperature and the snowflake  is displaying, the thermostat is operating correctly. Contact an air conditioning contractor for assistance.
The furnace cycles too frequently or the system cycle length is too short or too long.	Adjust heat cycle rate in the Customize Your Thermostat section.
The thermostat current setting does not match the displayed room temperature to within plus or minus 1°.	<ul style="list-style-type: none"> • Plug the wiring hole in the wall behind the mounting plate with insulation to prevent drafts that can adversely affect thermostat operation. • Be aware that it is normal for the current setting and the displayed room temperature to differ occasionally. • During recovery from setback or setup, setting and displayed room temperatures can differ for up to 30 minutes after recovery period.
System on indicator ( = heat;  = cool) is lighted, but no warm or cool air is coming from the registers.	Wait five minutes after seeing the flame or snowflake and check the registers again. If there is no hot or cool air coming from the registers, refer to "Heating does not come on" or "Cooling does not come on." If everything is checked contact you heating and air conditioning contractor.
Thermostat backlight appears dim.	<ul style="list-style-type: none"> • Wait until Replace Battery indicator is illuminated and replace batteries. • Replace batteries now.
System on indicator  is flashing.	<ul style="list-style-type: none"> • Minimum off-timer is in effect. Wait five minutes until the minimum off-timer is complete.

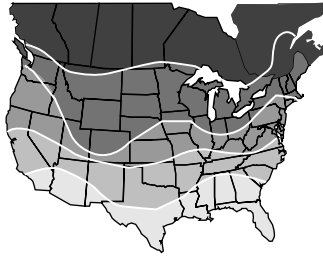

PERCENT OF HEATING COSTS YOU CAN SAVE

SAVINGS FOR ONCE-A-DAY 10°F (5°C) DECREASE*

- 6 TO 8%
- 9 TO 11%
- 12 TO 13%
- 14 TO 15%
- 16 TO 18%



HEAT

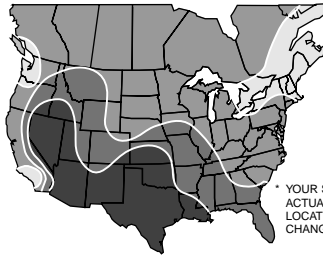

PERCENT OF COOLING COSTS YOU CAN SAVE

SAVINGS FOR ONCE-A-DAY 10°F (5°C) INCREASE*

- 7 TO 9%
- 10 TO 11%
- 12 TO 14%
- 14 TO 19%



COOL

* YOUR SAVINGS DEPENDS ON HOME SIZE AND ACTUAL HEAT LOSS OR GAIN, GEOGRAPHIC LOCATION, FREQUENCY OF TEMPERATURES CHANGE, AND RANGE IN DEGREES OF CHANGE.

M12545

Limited One-Year Warranty

Honeywell warrants this product, excluding battery, to be free from defects in the workmanship or materials, under normal use and service, for a period of one (1) year from the date of purchase by the consumer. If, at any time during the warranty period, the product is defective or malfunctions, Honeywell shall repair or replace it (at Honeywell's option) within a reasonable period of time.

If the product is defective,

- (i) return it, with a bill of sale or other dated proof of purchase, to the retailer from which you purchased it, or
- (ii) package it carefully, along with proof of purchase (including date of purchase) and a short description of the malfunction, and mail it, postage prepaid, to the following address:

Honeywell Return Goods
 Dock 4, MN10-3860
 1885 Douglas Dr N
 Golden Valley, MN 55422

Canada: Honeywell Limited/Honeywell Limitée
 Product Services ON15
 35 Dynamic Dr
 Scarborough, Ontario M1V 4Z9

This warranty does not cover removal or reinstallation costs. This warranty shall not apply if it is shown by Honeywell that the defect or malfunction was caused by damage which occurred while the product was in the possession of a consumer.

Honeywell's sole responsibility shall be to repair or replace the product within the terms stated above. HONEYWELL SHALL NOT BE LIABLE FOR ANY LOSS OR DAMAGE OF ANY KIND, INCLUDING ANY INCIDENTAL OR CONSEQUENTIAL DAMAGES RESULTING, DIRECTLY OR INDIRECTLY, FROM ANY BREACH OF ANY WARRANTY, EXPRESS OR IMPLIED, OR ANY OTHER FAILURE OF THIS PRODUCT. Some states do not allow the exclusion or limitation of incidental or consequential damages, so this limitation may not apply to you.

THIS WARRANTY IS THE ONLY EXPRESS WARRANTY HONEYWELL MAKES ON THIS PRODUCT. THE DURATION OF ANY IMPLIED WARRANTIES, INCLUDING THE WARRANTIES OF MERCHANTABILITY AND FITNESS FOR A PARTICULAR PURPOSE, IS HEREBY LIMITED TO THE ONE YEAR DURATION OF THIS WARRANTY. Some states do not allow limitations on how long an implied warranty lasts, so the above limitation may not apply to you.

This warranty gives you specific legal rights, and you may have other rights which vary from state to state.

If you have any questions concerning this warranty, please write Honeywell Customer Relations, 1885 Douglas Dr N, MN10-1461, Golden Valley, MN 55422. In Canada, write Retail Products ON15,

Honeywell Limited/Honeywell Limitée, 35 Dynamic Dr, Scarborough, Ontario M1V 4Z9.

Honeywell

Automation and Control Solutions

Honeywell
 1985 Douglas Drive North
 Golden Valley, MN 55422

Honeywell Limited-Honeywell Limitée
 35 Dynamic Drive
 Scarborough, Ontario
 M1V 4Z9

